

Article number: 20240428450

Description: E+G Telescope-Lear motion bearings GN 2404-28-450

Measures

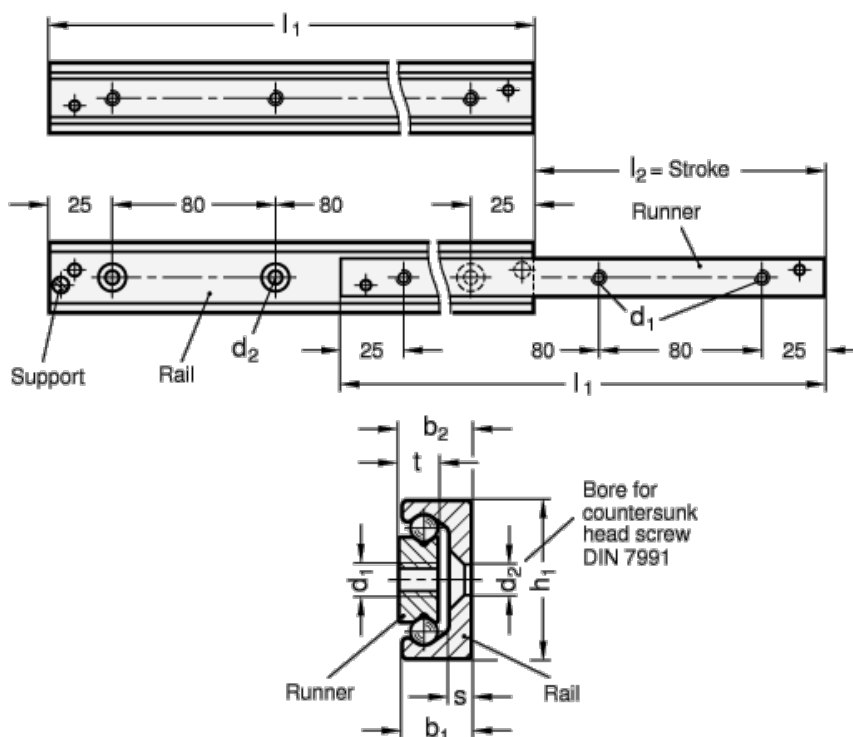

$b_1 = 12.3$

$b_2 = 12.9$

$d_1 = M5$

$d_2 = 5.5$

$h_1 = 28$

$L_1 = 232 - 450$

$s = 4$

$t = 7$

Weight in (g) = 990